

LEGO DIGITAL DESIGNER 4.2

Model Name:
Sea Monster robot

Number of Bricks: 39

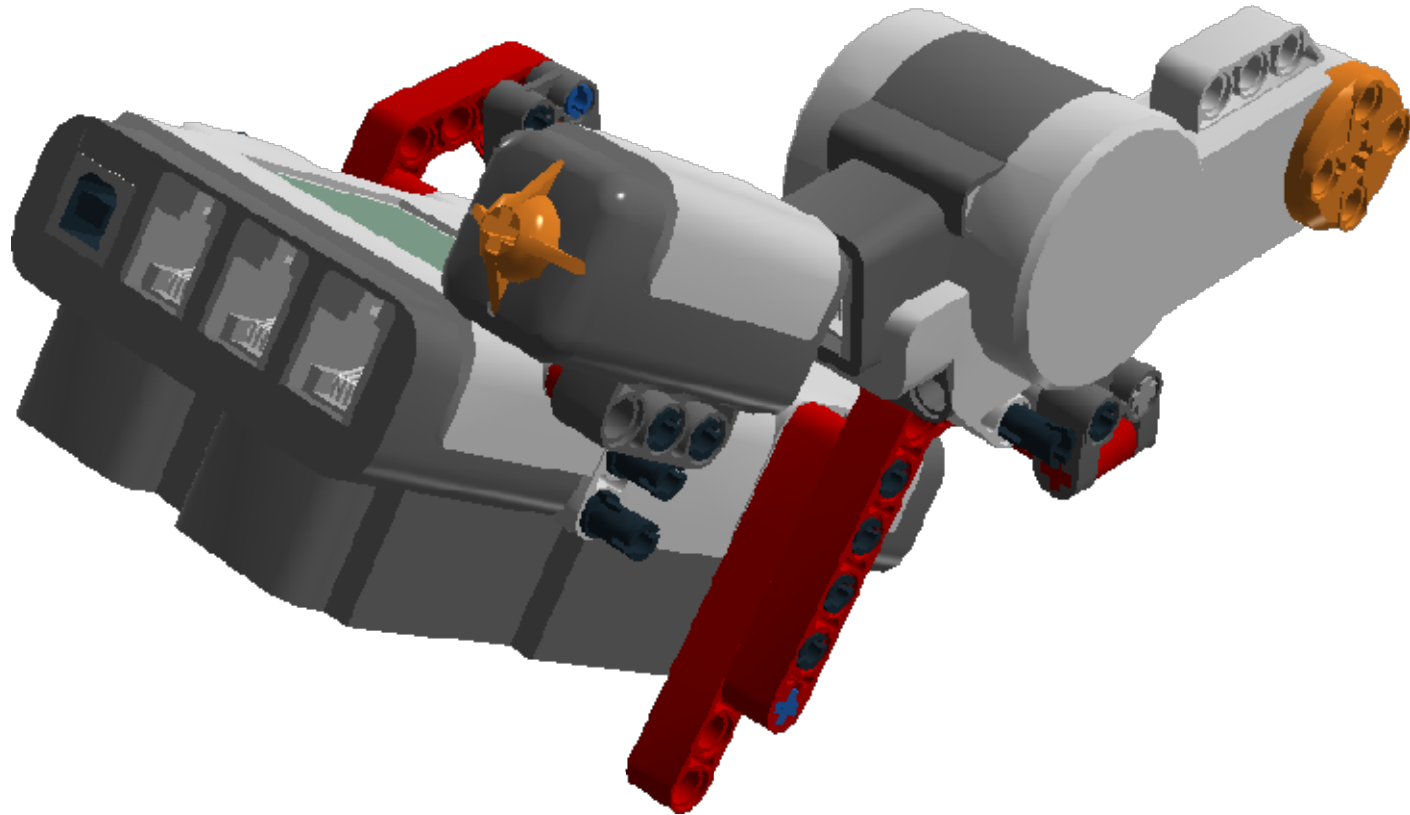

Step 1 of 15

1 x



1 x

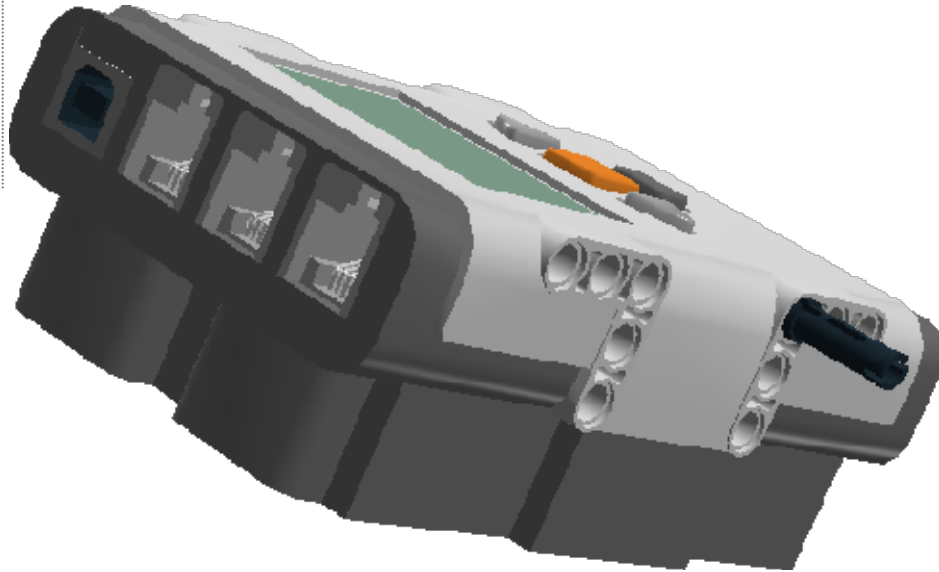

Step 2 of 15

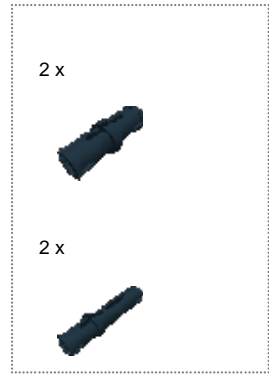

Step 3 of 15

1 x

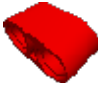

1 x



2 x



Step 4 of 15

1 x



Step 5 of 15

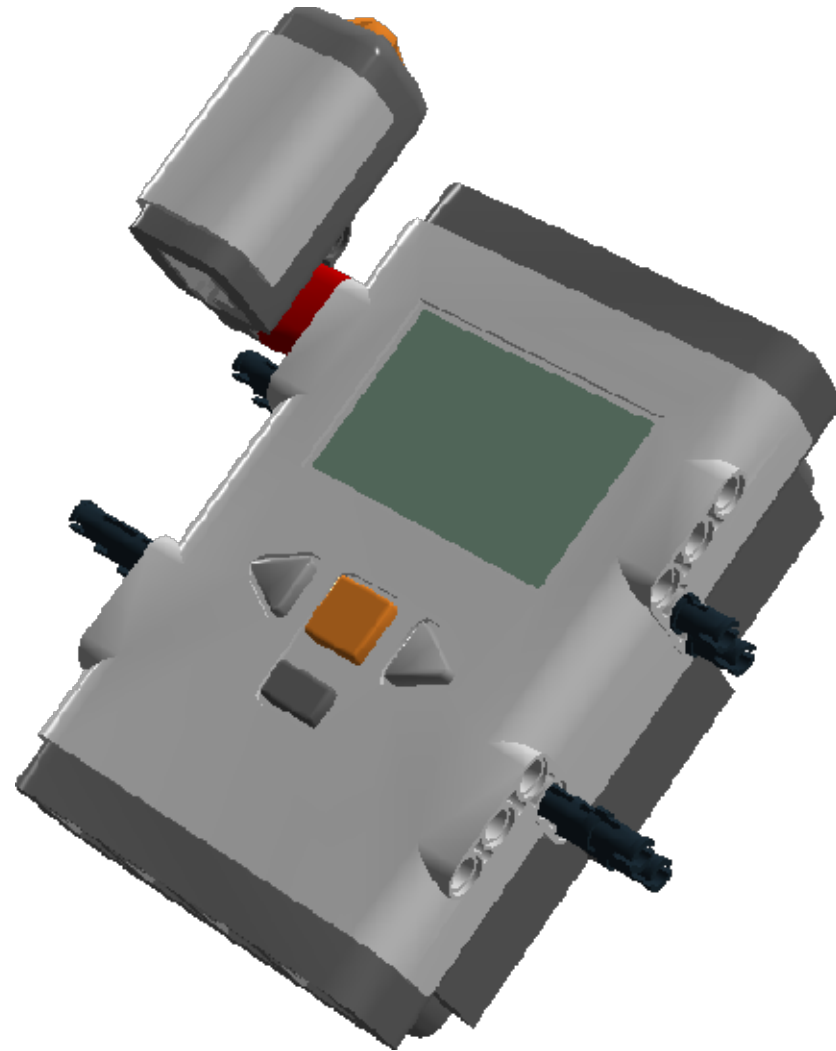
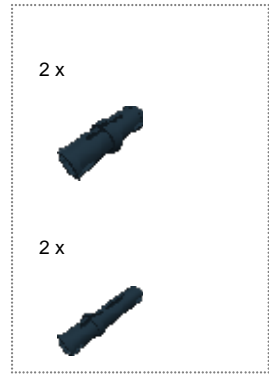

Step 6 of 15

3 x



1 x



Step 7 of 15

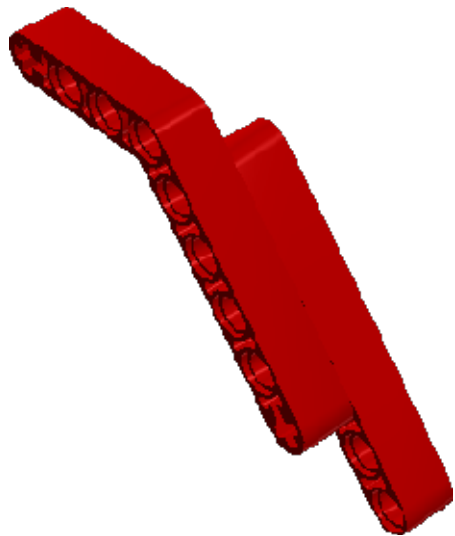
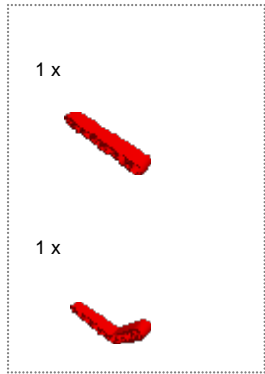

Step 8 of 15

1 x



2 x



1 x

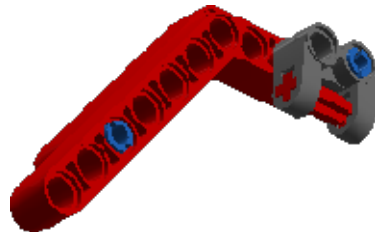

Step 9 of 15

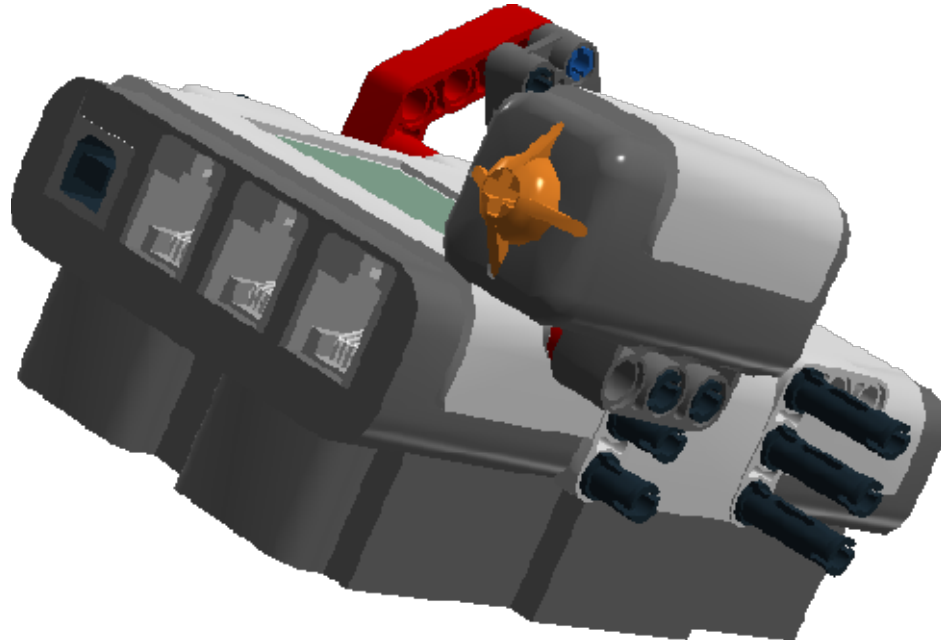

Step 10 of 15

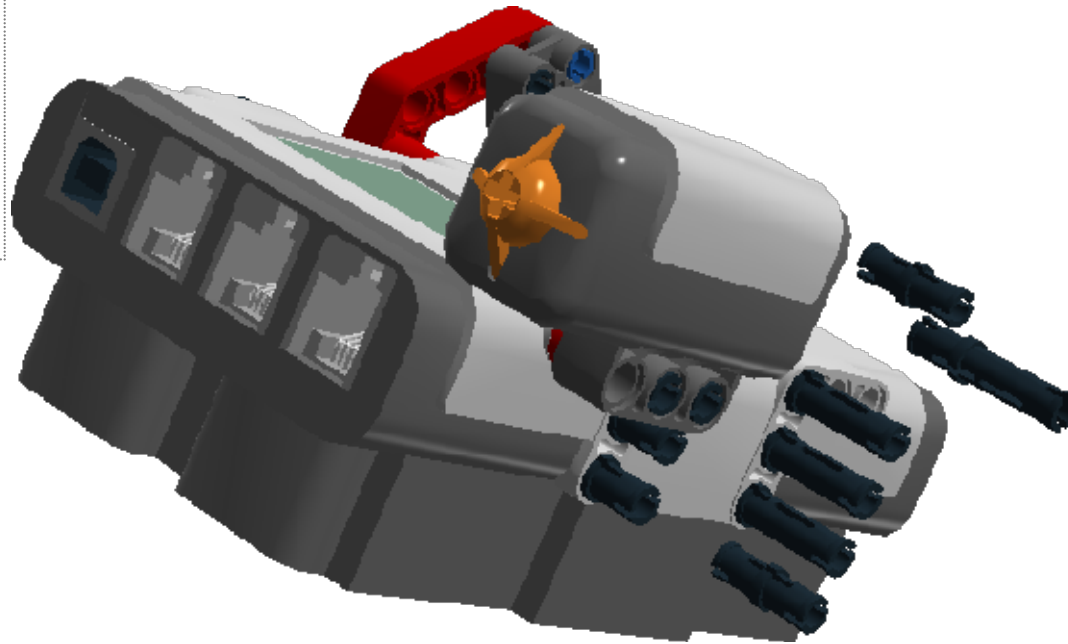
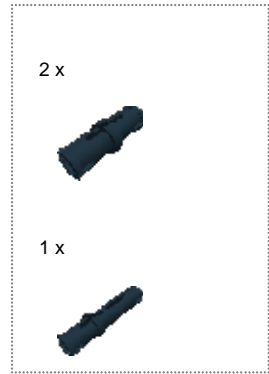

Step 11 of 15

1 x

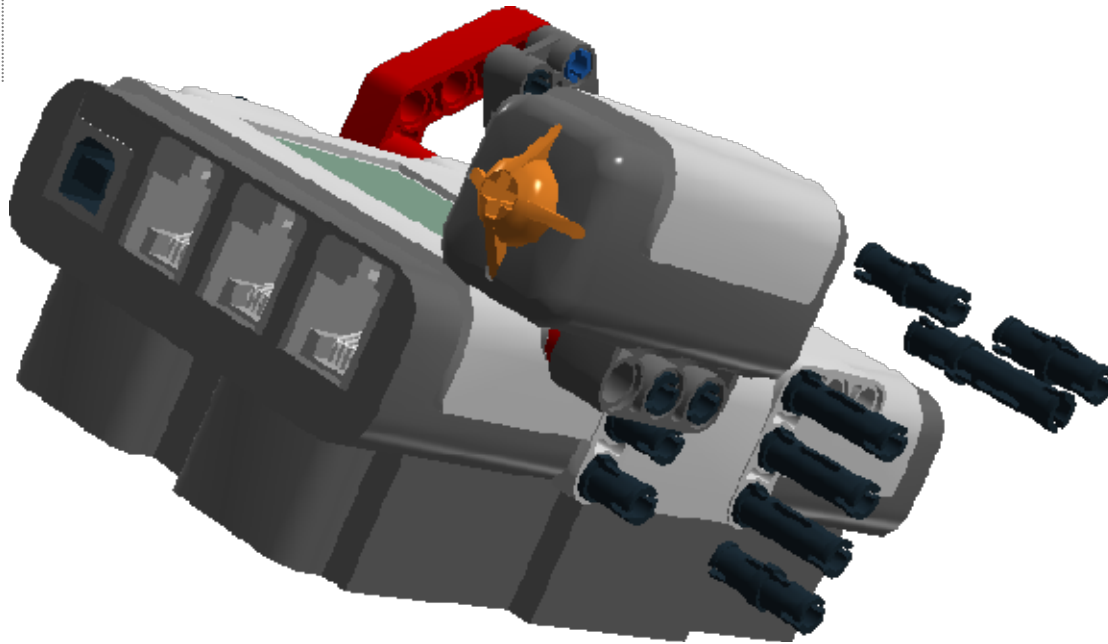

Step 12 of 15

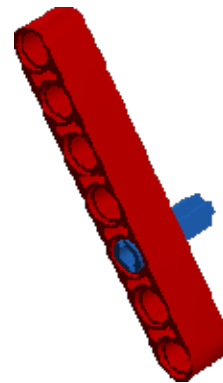
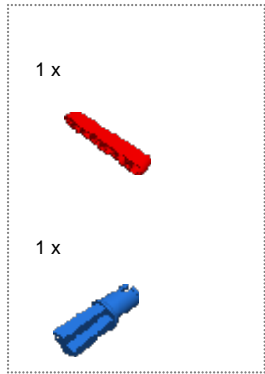

Step 13 of 15

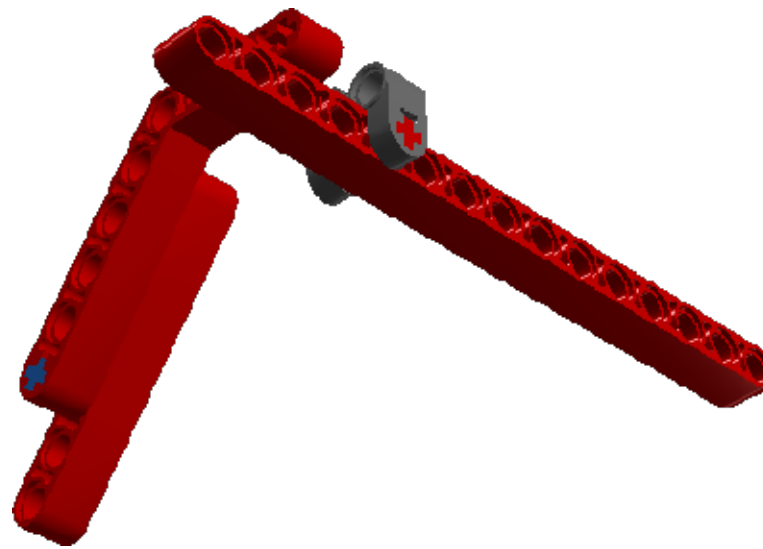
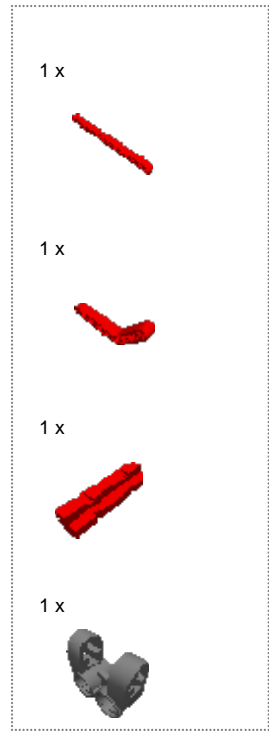

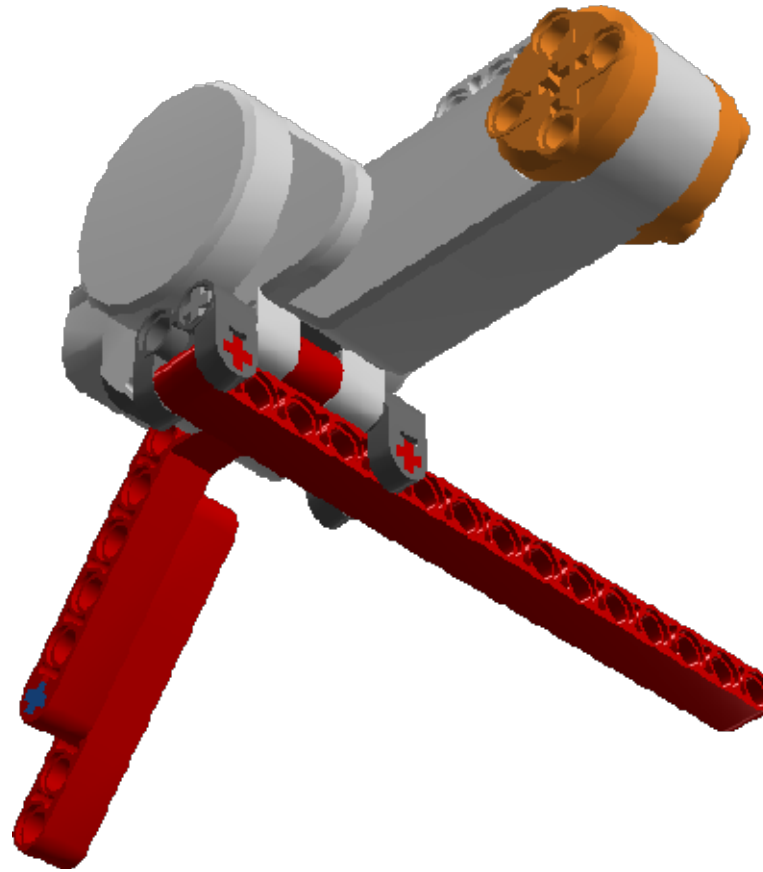
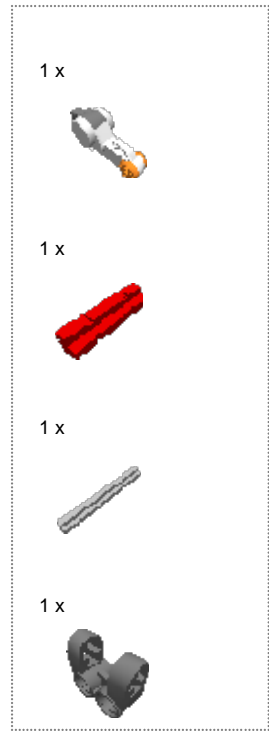

Step 14 of 15

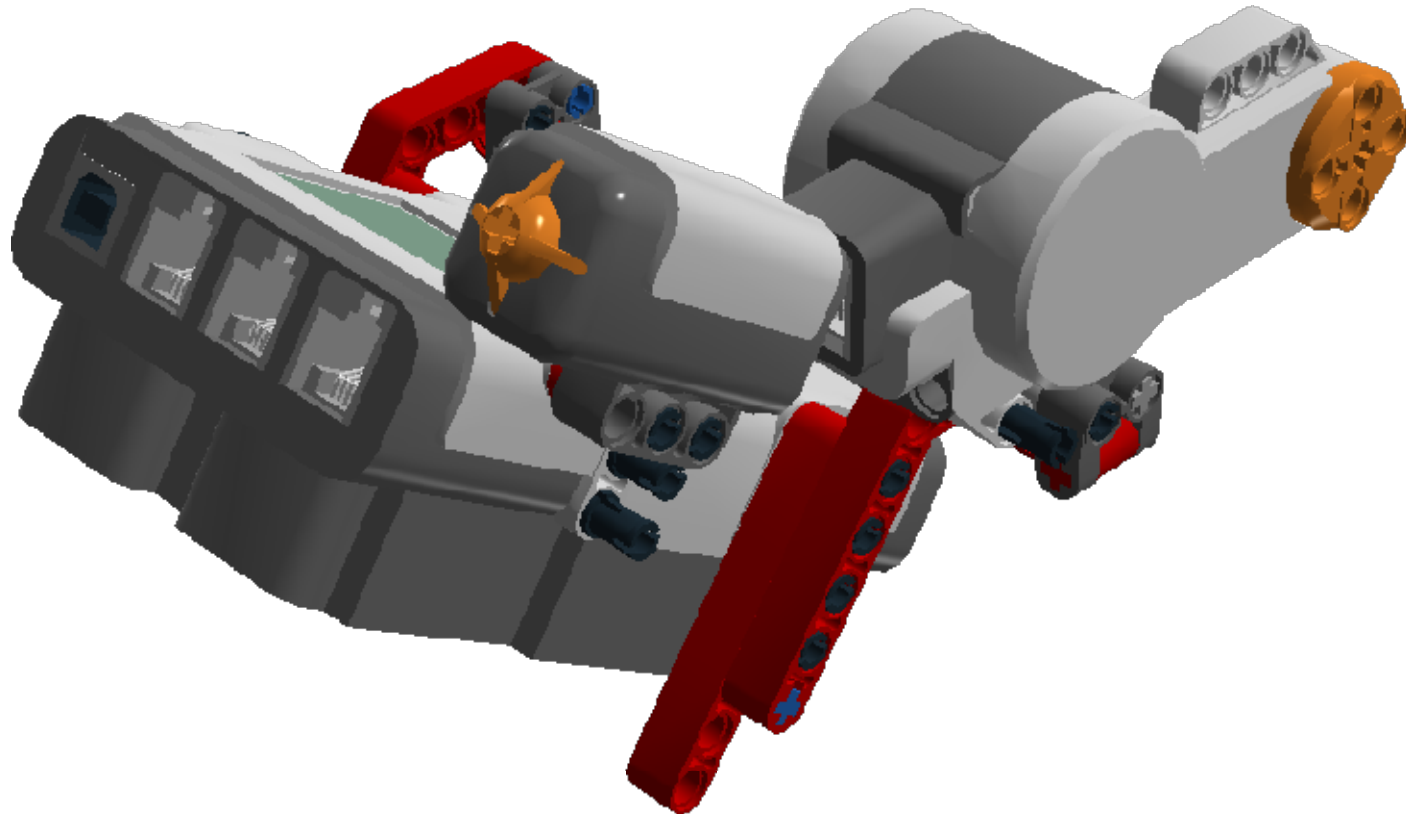

Step 15 of 15





1 x  4296929 Push sensor - Bright Orange,Medium Stone Grey,Dark Stone Grey,Light Stone Grey

1 x  4297008 Tacho Motor - Bright Orange,Dark Stone Grey,Light Stone Grey

1 x  4520887 NXT - Black,Bright Orange,Sand Green,Medium Stone Grey,Dark Stone Grey,Light Stone Grey,Cool silver, drum lacq

1 x  4185664 TECHNIC 2M BEAM - Bright Red

2 x  4495933 TECHNIC 7M BEAM - Bright Red

1 x  4542575 TECHNIC 15M BEAM - Bright Red

2 x  4254591 TECHNIC ANGULAR BEAM 4X6 - Bright Red

3 x  4142865 2M CROSS AXLE W. GROOVE - Bright Red

11 x  4121715 CONNECTOR PEG W. FRICTION - Black

3 x  4206482 CONN.BUSH W.FRIC./CROSSALE - Bright Blue

9 x  655826 CONNECTOR PEG W. FRICTION 3M - Black

1 x  4211639 CROSS AXLE 5M - Medium Stone Grey

3 x  4234599 TECHNIC CROSS BLOCK/FORK 2X2 - Dark Stone Grey

© 2011 The LEGO Group. All rights reserved.
Use of the LEGO Digital Designer html print tool, signifies your agreement to the terms of use.